

Av. Adeje 300, s/n · E-38678 · Playa Paraíso · Tenerife · Spain

Tel.: + 34 922 75 74 35

[h10.atlantic.sunset@h10hotels.com](mailto:h10.atlantic.sunset@h10hotels.com)

[www.hotelh10atlanticsunset.com](http://www.hotelh10atlanticsunset.com)

 @h10atlanticsunset

 @h10atlanticsunset

Information and bookings:

Tel.: +34 900 444 466

[reservations@h10hotels.com](mailto:reservations@h10hotels.com)

[www.h10hotels.com](http://www.h10hotels.com)

 @h10hotels

 @H10.Hotels

 @h10hotels

## Setting

The **H10 Atlantic Sunset** is located on a spit of land surrounded by the sea in Playa Paraíso, a very quiet area in southern Tenerife, directly facing the island of La Gomera and with spectacular views of the sunset all year round. It's only 15 minutes by car from Costa Adeje, one of the best known tourist destinations on the island, with vast protected natural parks, beautiful beaches and rich marine life – including one of the world's most important colonies of whales and dolphins.

4 km from Golf Costa Adeje

7 km from Tenerife Top Training

10 km from Costa Adeje

12 km from Magma Arte & Congresos convention centre

12 km from Siam Park

12 km from Playa de las Américas beach

15 km from Los Cristianos Port

21 km from the Los Gigantes cliffs

26 km from Tenerife South airport

36 km from Teide National Park

64 km from Loro Parque theme park

86 km from Santa Cruz de Tenerife

90 km from Tenerife North airport

90 km from La Laguna

Coordinates: 28° 11' 88.11" N / 16° 77' 64.43" W



## Description

Facing the sea in Playa Paraíso, the **H10 Atlantic Sunset** is a brand new five-star resort. It has modern rooms, spectacular terraces overlooking the ocean, large swimming pools, one of them with a water park area for children, a wide range of dining options, a Despacio Spa Centre, Privilege, Exclusive Rooms and Services and an entertainment programme for the whole family.

### 291 rooms

**Complimentary Wi-Fi** throughout the hotel

**5 swimming pools** (a main saltwater pool, a heated family pool, a heated saltwater infinity pool recommended for adults, a heated infinity pool exclusively for Privilege guests and one in the Fun Area)

**Fun Area:** includes a water park area, Daisy Club area, Miniclub with entertainment for children, Minidisco and playground

**5 restaurants and 6 bars**

**Privilege, Exclusive Rooms and Services**

**Despacio Spa Centre with hairdresser service (\$) and free 24-hour gym**

**2 meeting rooms and several spaces for holding events**

**Room service (\$)**

**Dog friendly** (up to 5kg, not allowed in common areas, €85/stay)

**Car park (\$) and electric vehicle charging point**

**Free transfer to Playa de las Américas beach**

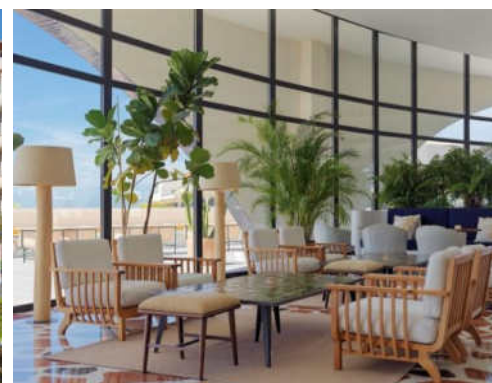

## Rooms

The **H10 Atlantic Sunset** has bright and spacious rooms, decorated in neutral colours and fully equipped with all the amenities:

- 49" Smart TV with international channels and Chromecast to play content from your mobile or tablet
- Complimentary bottle of water upon arrival
- Nespresso machine with free daily restocking of 100% compostable capsules and kettle
- Minibar (\$ according to consumption). Consumption is free for guests under the All Inclusive programme (restocking every 2 days).
- Bathrobe and slippers
- Complimentary in-room safe
- Air conditioning
- Fully equipped bathroom with rain effect shower, professional hairdryer, magnifying mirror and eco-friendly dispensers from the Earth Collection



DOUBLE ROOM

**Double Rooms:** 41 m<sup>2</sup> rooms with a furnished balcony measuring between 9 and 15 m<sup>2</sup> and with views of the street or swimming pool. They feature either a King Size bed (2 x 2 m) or 1.10 x 2 m twin beds as well as a sofa bed. They can accommodate up to 3 adults.



DOUBLE ROOM WITH SIDE SEA VIEW

**Double Rooms with side sea view:** they offer the same features as the Double Rooms but with sides views of the sea.

**Sea View Double Rooms:** they offer the same features as the Double Rooms but with views of the sea.



SWIM-UP ROOM VIEW FROM THE OUTSIDE

**Swim-Up Rooms:** spectacular 41 m<sup>2</sup> rooms which offer the possibility of diving straight into the water from the room's terrace which measures between 18 - 26 m<sup>2</sup>. They feature either a King Size bed (2 x 2 m) and a sofa bed. They can accommodate up to 3 adults.



FAMILY ROOM WITH SIDE SEA VIEW

**Family Rooms:** 41 m<sup>2</sup> rooms that feature a balcony measuring between 9 and 15 m<sup>2</sup> and with views of the street or swimming pool. They feature either a King Size bed (2 x 2 m) or 1.10 x 2 m twin beds as well as a 1.50 m double sofa bed and the possibility of adding an extra bed. They can accommodate up to 2 adults + 3 children or 3 adults + 1 child.

**Family Rooms with side sea view:** they offer the same features as the Family Rooms but with side views of the sea.

**Sea View Family Rooms:** they offer the same features as the Family Rooms but with views of the sea.



JUNIOR SUITE

**Junior Suites:** exclusive 67 m<sup>2</sup> rooms with a bedroom with a King Size bed (2 x 2 m) and a living room with sofa bed. They come with a large balcony measuring between 15 and 22 m<sup>2</sup>. They can accommodate up to 2 adults + 3 children or 3 adults + 1 child.

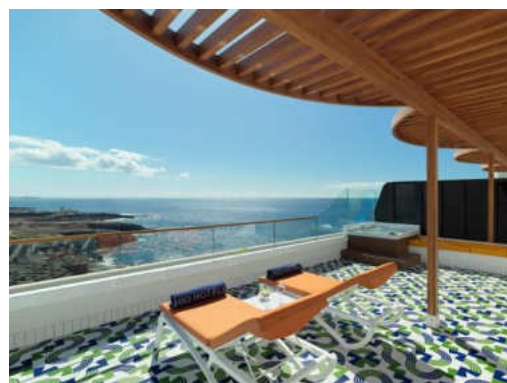

ROOFTOP SUITE TERRACE

**Rooftop Suites:** impressive 99 m<sup>2</sup> duplexes on the ground floor with a bedroom area featuring a King Size bed (2 x 2 m), fully equipped bathroom, plus living room with sofa bed, separate toilet and 16 m<sup>2</sup> balcony. The top floor features a spectacular 39 m<sup>2</sup> terrace with views of the sea or of La Gomera island and is equipped with Jacuzzi, sun loungers and a separate toilet. They come with a 49" Smart TV in the bedroom and another in the living room. They can accommodate up to 2 adults + 3 children or 3 adults + 1 child.

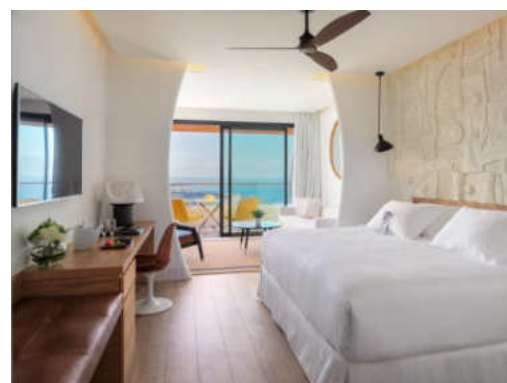

PRIVILEGE ROOM

**Privilege Rooms:** rooms with sea views exclusive for guests who have signed up for Privilege, Exclusive Rooms and Services. They measure 41 m<sup>2</sup> and come with a balcony measuring between 9 and 15 m<sup>2</sup>. They feature either a King Size bed (2 x 2 m) or 1.10 x 2 m twin beds as well as a sofa bed. They can accommodate up to 3 adults or 2 adults + 2 children and in addition to the services offered in the other rooms, they also offer:

- Welcome gift
- Pillow menu and pillow-top mattress
- Exclusive pool towel
- Night-time turndown service
- Room cleaning and preparation (twice a day, on request)
- Late check-out (subject to availability)



PRIVILEGE JUNIOR SUITE LIVING ROOM

**Privilege Junior Suites:** magnificent 67 m<sup>2</sup> rooms that include a bedroom, a separate living room and a large balcony measuring between 15 and 22 m<sup>2</sup> with sea views. They feature a King Size bed (2 x 2 m) as well as a 1.50 m double sofa bed and can accommodate up to 2 adults + 3 children or 3 adults + 1 child. They are exclusively for guests who have signed up for Privilege, Exclusive Rooms and Services and, as well as the services common to other rooms, they also offer:

- 49" Smart TV in the bedroom and another in the living room
- Welcome gift
- Pillow menu and pillow-top mattress
- Exclusive pool towel
- Night-time turndown service
- Room cleaning and preparation (twice a day, on request)
- Late check-out (subject to availability)



PRIVILEGE SUITE BEDROOM

**Privilege Suites:** measuring 92 m<sup>2</sup> and with stunning views of the Atlantic Ocean and the island of La Gomera, the Privilege Suites are the most exclusive rooms in the hotel. They feature two very bright rooms, a bedroom with a 49" Smart TV and a living room with a 55" Smart TV, each with a fully equipped bathroom. They come with a large terrace measuring between 42 and 77 m<sup>2</sup> with spectacular sea views, jacuzzi and sun loungers. They feature a King Size bed (2 x 2 m) as well as a 1.50 m double sofa bed and can accommodate up to 2 adults + 3 children or 3 adults + 1 child. They offer all the exclusive services for Privilege, Exclusive Rooms and Services guests.

**Note:** the décor, size and views of the rooms may vary depending on the room allocated.

## Restaurants and bars

**Central Market:** buffet restaurant offering market cuisine with themed corners featuring show cooking and a terrace with amazing sea views.

**Sakura Teppanyaki:** Asian restaurant with Teppanyaki grills. Exclusively for dinner (recommended for adults only).

**Stromboli:** à la carte Italian restaurant with pizza oven on display. Exclusively for dinner.

**Route 66:** american cuisine à la carte restaurant specialised in grilled meats. Exclusive service for dinners.

**The View - Privilege Lounge & Restaurant\*:** à la carte restaurant featuring international market cuisine located next to the Privilege Lounge. Breakfasts and dinner service.

**La Boîte Dinner & Show (seasonal):** a pleasant space to spend a fun evening. During the evening it offers different live shows, as well as the Daisy Minidisco so that the children can have a great time. And, depending on the season, La Boîte offers an innovative show-dinner concept.

**The Circle Pool & Snack Bar:** poolside snack and drinks service.

**Sunset Infinity Pool & Bar\*:** located on a terrace on the top floor of the Privilege building next to a spectacular infinity pool with magnificent sea views.

**Mike's Coffee:** specializing in tea, coffee and pastries, as well as a selection of smoothies, ideal for cooling down when the weather gets hot.

**The Dome Bar:** bar located in the lobby that features a terrace with spectacular views of the sea.

**Rooftop Upper Events Bar (seasonal):** located on a terrace on the top floor of the Front Desk building with panoramic sea views. Ideal for holding events.

Entry to the restaurants Sakura Teppanyaki, Stromboli, Route 66 and La Boîte Dinner & Show is with advance booking and subject to availability.

To gain access to the restaurants, please respect the dress code, avoiding swimwear except in the pool bars/restaurants during daylight hours and sleeveless shirts for men.

\* Exclusively for guests who have signed up for Privilege, Exclusive Rooms and Services.



CENTRAL MARKET

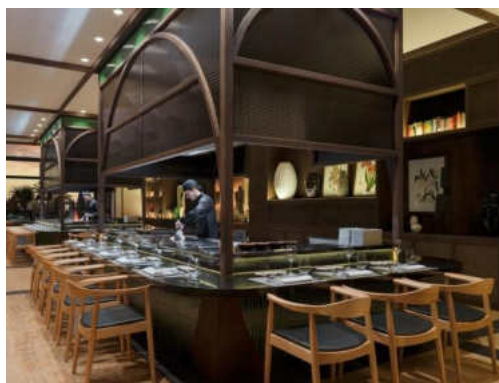

SAKURA TEPPANYAKI



STROMBOLI



LA BOÎTE DINNER & SHOW

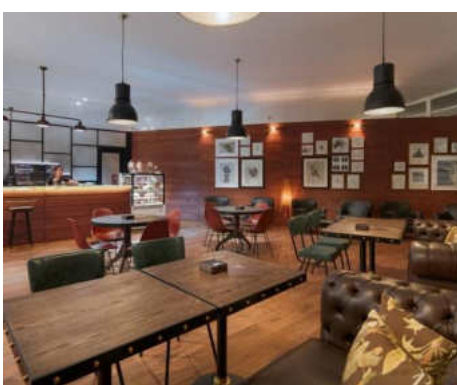

MIKE'S COFFEE

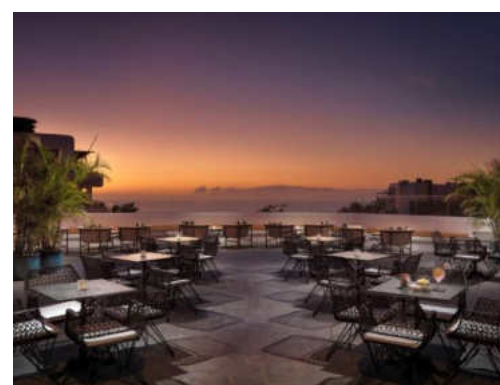

THE DOME BAR TERRACE

## All Inclusive

Meals, national and international drinks from top brands, cocktails and snacks.

Complimentary minibar (restocking every 2 days).

Evening meals at the hotel's themed restaurants (Sakura Teppanyaki, Stromboli, Route 66 and La Boîte Dinner & Show).

Limited access and advance booking required.

The Privilege service and Despacio Spa Centre are not included in the All Inclusive programme.

Drinks included as per the All Inclusive programme menu.

*Privilege*

For a unique experience, the **H10 Atlantic Sunset** offers the possibility of signing up for **Privilege, Exclusive Rooms and Services**.

Only guests who contract the Privilege service can access the following:

- Privilege Lounge with complimentary drinks and snacks, TV and Internet.
- Sunset Infinity Pool & Bar terrace located on the top floor of the Privilege building with spectacular sea views.
- À la carte breakfast and dinner at the exclusive The View Restaurant, located next to the Privilege Lounge.

In addition, guests can enjoy the following services:

- Evening meals at the hotel's themed restaurants (Sakura Teppanyaki, Stromboli, Route 66 and La Boîte Dinner & Show). Advance booking is required.
- Free access to the Despacio Spa Centre and discount on treatments.
- Personalized check-in and check-out
- Late check-out (subject to availability)
- Porter service
- Personalized Guest Service
- Welcome gift

**Privilege Rooms:** see details in the Rooms section.



PRIVILEGE LOUNGE



THE VIEW RESTAURANT



SUNSET INFINITY POOL & BAR

## despacio spa centre

The **H10 Atlantic Sunset** features a **Despacio Spa Centre**, where you can unwind and pamper your body and mind. The centre offers:

Wet zone

Jacuzzi

Sauna and Turkish bath

24-hour gym with bodybuilding equipment, spinning bikes, elliptical machines, treadmills, rowing machine, abdominal and dip stations, suspension training, gym balls and fitness mats.

Massages and beauty treatments

Hairdresser service

It is free to access the gym, but there is an additional charge for all other Despacio Spa Centre services. Entrance to the Despacio Spa Centre for over 16 years old.



WET ZONE

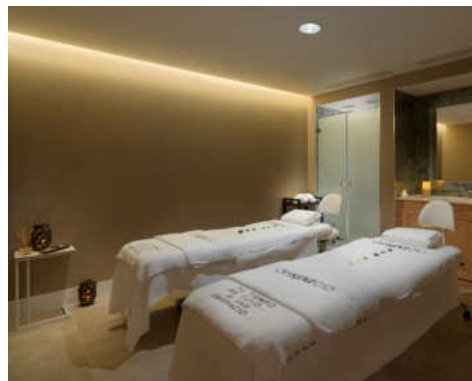

TREATMENT ROOMS



GYM



The **H10 Atlantic Sunset** features a **Fun Area**, a space with specialized entertainment facilities and services for families to have a great time. It offers:

**Water Park:** heated freshwater family swimming pool, slides, water jets and water games area

**Playground**

**Daisy Club:** large playroom with a variety of games and activities for children of different ages such as painting, arts and crafts, etc. It has an area for snacks, stage and Minidisco with Daisy.

**Miniclub:** a complete entertainment programme for children aged 4–12, led by our team of professionals and accompanied by our mascot Daisy.



WATER PARK AREA



PLAYGROUND



DAISY CLUB



At the **H10 Atlantic Sunset**, you'll find an extensive programme of daytime and night-time activities led by our **Blue Team** entertainment team.

During the day, guests can enjoy an entertainment programme focused on wellness and fitness such as Aquagym, Aquarunning and other aquatic activities.

And at night, there's lots of entertainment on offer with shows, live music and themed nights.



The **H10 Atlantic Sunset** offers two rooms with everything needed to hold business meetings or any other type of event. The hotel also has La Boite which has a stage and the outside areas of the hotel offer unique spaces for holding drinks receptions and events with spectacular views of the sea.

**MEETINGS & EVENTS**  
H10 HOTELS

Spaces for events	m <sup>2</sup>	Height	CAPACITY							
			Drinks reception	Theatre	Classroom	Boardroom	Banquet	Cabaret	U SHAPE	O-SHAPE
GARDEN ROOM	168	3 m	120	140	80	40	80	60	50	60
OCEAN ROOM	174	3 m	120	140	80	40	80	60	50	60
LA BOÎTE RESTAURANT	405	4.4 m	-	180	90	-	150	-	-	-
SOLARIUM	417	-	350	-	-	-	150	-	-	-
ROOFTOP UPPER EVENTS BAR	678	-	200	-	-	-	-	-	-	-
SUNSET INFINITY POOL & BAR	632	-	100	-	-	-	-	-	-	-

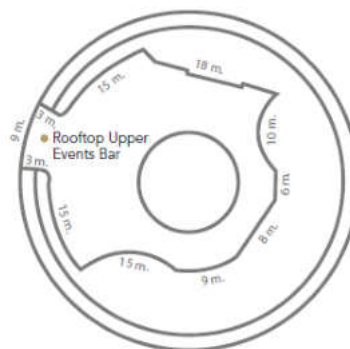
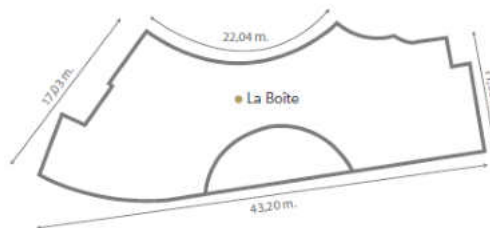
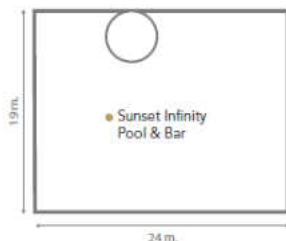
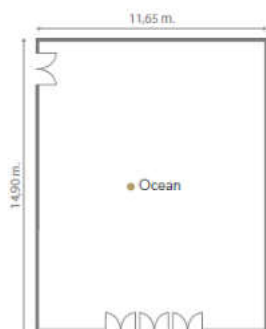
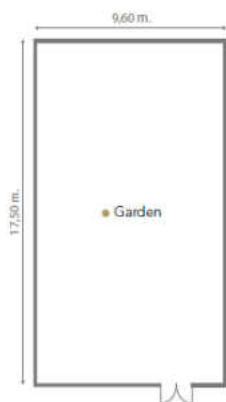



GARDEN ROOM



GARDEN ROOM



GARDEN ROOM

## perfect day

Weddings  
& Celebrations

At the **H10 Atlantic Sunset**, we take care of every detail so your celebration turns out just how you dreamed it would. The hotel is located in a unique setting and offers every service to ensure a perfect day: celebrations on the terraces with spectacular views of the sea, by the swimming pool, etc.



CELEBRATION ON THE TERRACE WITH SEA VIEWS



BANQUET ON THE TERRACE WITH SEA VIEWS

## Golf

The **H10 Atlantic Sunset** is located near several top-class golf courses. Our team of professionals will advise you about the best golf courses in the area, golf packages and special green fees.

## Quality Certificates and awards





<b>BOOKING.COM</b>	Traveller Review Award – 2023, 2021, 2020
<b>TRIPADVISOR</b>	Travellers' Choice – 2023, 2022, 2021, 2020
<b>CONDÉ NAST TRAVELER</b>	Gold List Hotel - 2022
<b>HOTELS.COM</b>	Loved by Guests - 2021
<b>BRITISH AIRWAYS</b>	Customer Excellence Award – 2022
<b>WORLD LUXURY SPA AWARDS</b>	Best Spa Experience - 2022



At H10 Hotels, we are committed to the environment, which is why **Stay Green** was created. This sustainability project aims to develop a responsible business model based on three primary lines of action: the elimination of plastics and waste reduction, energy efficiency and the use of green energy, and training and awareness programmes for both our employees and our guests.